

MTE

CIESSE



Caratteristiche generali
General features

Questa serie di estrattori costituita da 9 grandezze, è adatta ad estrarre aria viziata da capannoni, magazzini ecc. ed in tutti quei casi dove necessitano grande portate d'aria con pressioni relativamente basse. Temperature del fluido convogliato max +40° C servizio continuo.

CARATTERISTICHE COSTRUTTIVE

Telaio di base in lamiera zincata - girante con pale in polipropilene - mozzo in fusione alluminio - cappello di protezione in vetroresina - rete di protezione lato motore - motore trifase tipo chiuso a una velocità protezione IP54, tensione alimentazione 220/380V 50 Hz - motore trifase tipo chiuso a due velocità, protezione IP54, tensione alimentazione 380V 50 Hz.

ACCESSORI

Serranda a gravità - rete di protezione lato girante.

COSTRUZIONI SPECIALI

Possono essere forniti in esecuzione antiscintilla e motore a prova di esplosione con certificato di omologazione C.E.S.I.

MTE series, is composed of 9 models, it is suited to extract air from industrial factory units, warehouses etc. In all applications that require large airflow with low pressures, fluid temperature of +40° C maximum continuous service.

TECHNICAL SPECIFICATIONS

Support frame in galvanized sheet metal - polypropylene impeller - aluminium hub - protection grid - fiberglass reinforced plastic dome - threephase closed motor IP54 protection, voltage frequency 220/380V 50 Hz - threephase closed motor IP54 protection, voltage frequency 380V 50 Hz.

ACCESSORIES

Gravity shutter - protection grid.

SPECIAL CONSTRUCTIONS

MTE series can be supplied in explosion proof execution with C.E.S.I. certificate of approval.



MTE

Dimensioni d'ingombro Overall dimensions

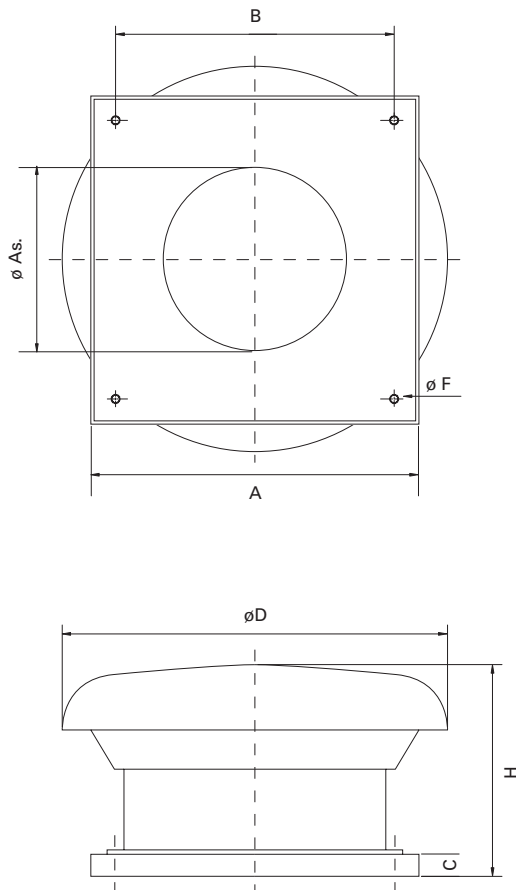

130

MODELLO TYPE	Peso Kg Weight Kg	A	B	D	As.	H	C	ϕF
MTE 400	25	650	550	800	410	530	40	15
MTE 450	27	700	600	800	460	540	40	15
MTE 500	30	750	650	1000	510	570	40	15
MTE 560	38	850	750	1000	570	700	50	15
MTE 630	48	900	800	1250	640	750	50	15
MTE 710	52	1000	900	1250	720	750	50	15
MTE 800	62	1100	1000	1600	810	800	50	15
MTE 900	70	1250	1150	1600	910	800	50	15
MTE 1000	88	1400	1300	1600	1010	800	50	15

MODELLO TYPE	Potenza kW Power kW	Giri Min RPM	Livello sonoro d(BA) Noise level dB(A)
MTE 404	0,18	1400	45
MTE 406	0,09	900	36
MTE 454	0,25	1400	52
MTE 456	0,09	900	46
MTE 504	0,37	1400	56
MTE 506	0,12	900	48
MTE 564	0,75	1400	65
MTE 566	0,18	900	56
MTE 568	0,09	700	48
MTE 634	1,5	1400	65
MTE 636	0,37	900	56
MTE 638	0,18	700	48
MTE 716	1,1	900	60
MTE 718	0,55	700	52
MTE 806	1,5	900	63
MTE 808	0,75	700	54
MTE 906	2,2	900	66
MTE 908	1,1	700	57
MTE 1006	3	900	71
MTE 1008	1,1	700	66

Prestazioni - Performances

MOD. TYPE	Portata Flowrate	PRESSIONE IN mmH2O - PRESSION IN mmH2O																			
		0	2	4	6	8	10	15	20												
MTE 404	m3/h	4500	4250	3800	3400	2900	2400														
MTE 406	m3/h	3000	2600	2000																	
MTE 454	m3/h	5650	5600	5450	5250	4800	4450														
MTE 456	m3/h	1500	1150	900	700																
MTE 504	m3/h	8300	8200	7900	7600	7000	6200	3750													
MTE 506	m3/h	6100	5000	4400	3500	2600															
MTE 564	m3/h	11800	11700	11500	11000	10500	10000	8950	5800												
MTE 566	m3/h	7600	7150	6500	5700	4700	3500														
MTE 568	m3/h	6200	5300	4250																	
MTE 634	m3/h	17000	16500	16200	1600	15400	14800	12200	10000												
MTE 636	m3/h	10500	10000	9500	8500	7400	6000														
MTE 638	m3/h	8600	7600	6000	4000																
MTE 716	m3/h	16500	16100	15800	14900	13500	11500														
MTE 718	m3/h	12800	12000	10300	8800	5900															
MTE 806	m3/h	25000	24300	23700	22500	21500	20000	14000													
MTE 808	m3/h	19000	18000	16500	14400	11500	8000														
MTE 906	m3/h	30000	29300	28400	28000	27000	25900	22200	16000												
MTE 908	m3/h	22800	21900	20500	19000	17300	15000														
MTE 1006	m3/h	34500	34000	33000	32200	31500	30300	27000	23000												
MTE 1008	m3/h	26000	25000	23900	22700	21300	19000	12000													

P (mm H₂O)

Prestazioni Performances

MTE

— Pt= Pressione totale(4 poli) - Total pressure (4 poles) — Pt= Pressione totale (6 poli) - Total pressure (6 poles) — Pt= Pressione totale (8 poli) - Total pressure (8 poles)

mod. MTE 404-406

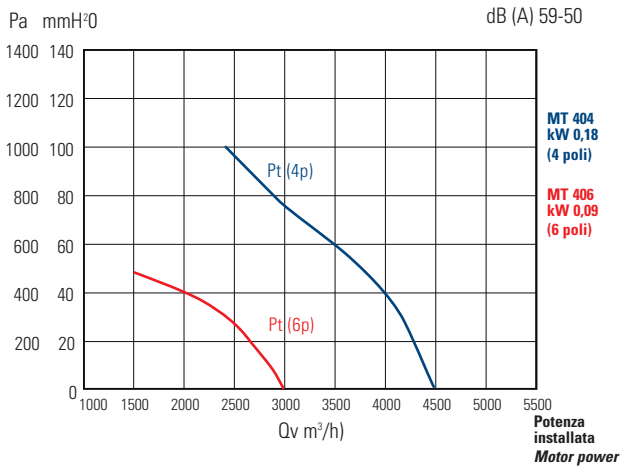

mod. MTE 454-456

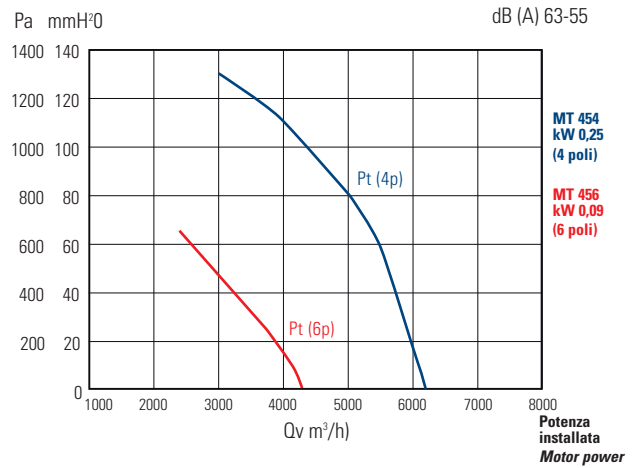

mod. MTE 504-506

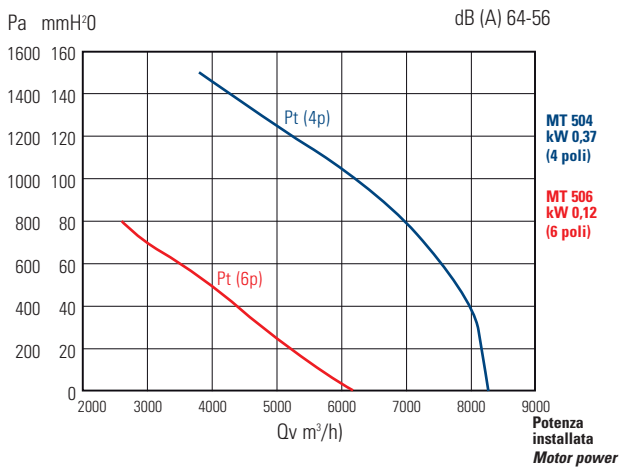

mod. MTE 564-566-568

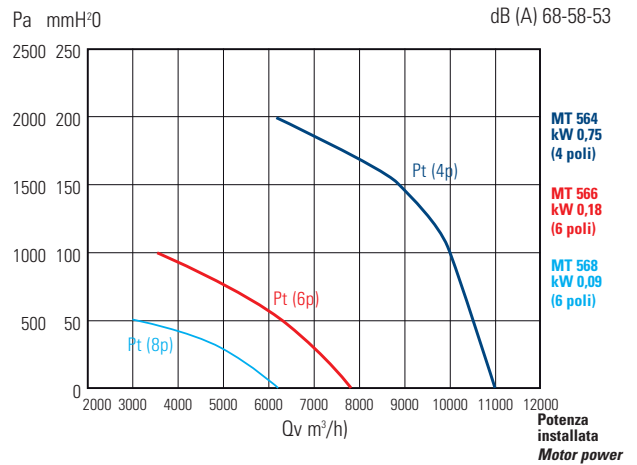

mod. MTE 634-636-638

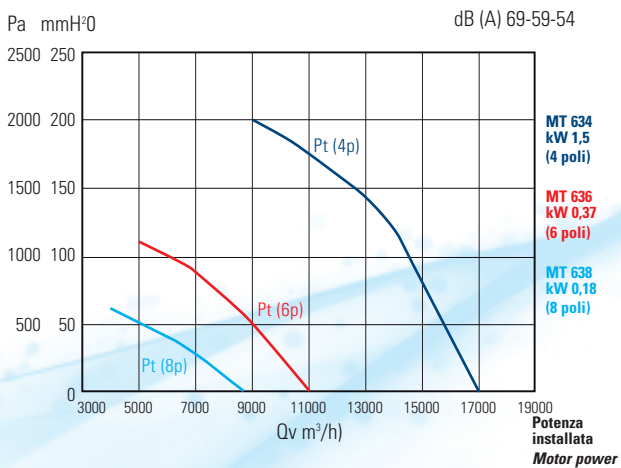

mod. MTE 716-718

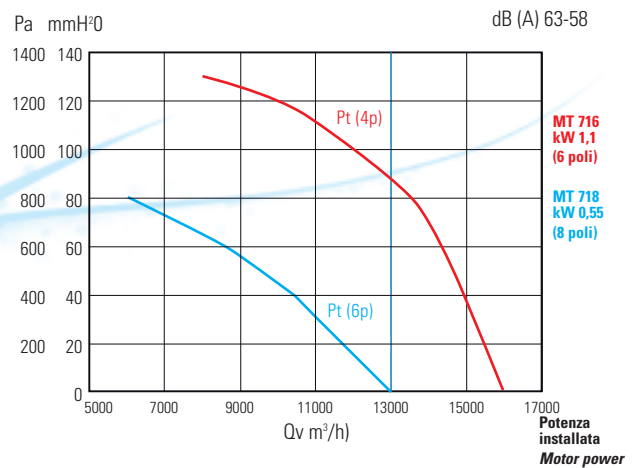

— Pt= Pressione totale(4 poli) - Total pressure (4 poles) — Pt= Pressione totale (6 poli) - Total pressure (6 poles) — Pt= Pressione totale (8 poli) - Total pressure (8 poles)

mod. MTV 806-808

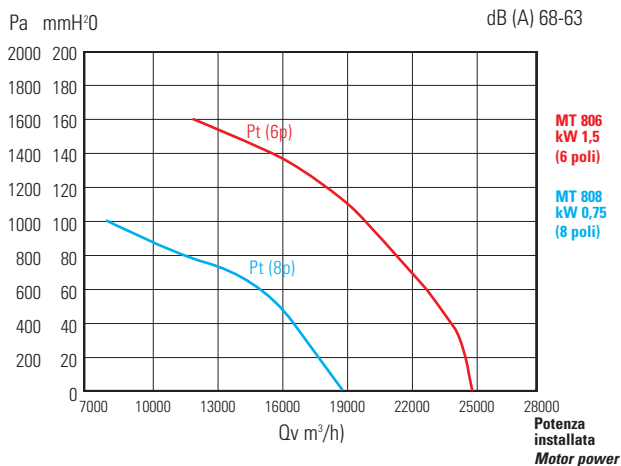

mod. MTV 906-908

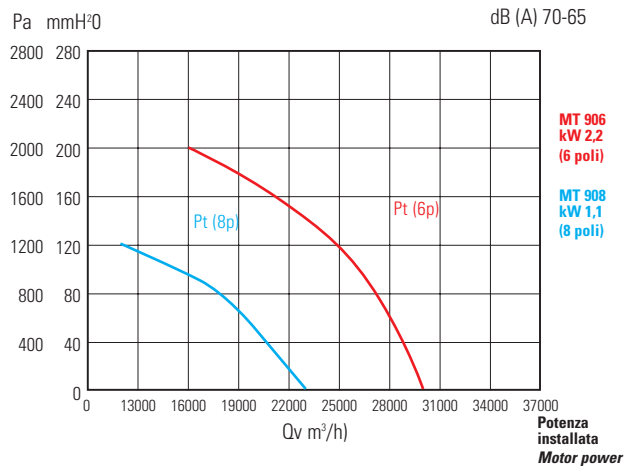

mod. MTV 1006-1008

